



Operation & Maintenance Manual



CoolAir 12

Table of Contents:

1. Safety Rules.....	2
2. Names of Parts.....	3
3. Accessories.....	3
4. Operation Panel	4
5. Operating Instructions.....	6
6. Installation.....	6
7. Maintenance.....	7
10. Troubleshooting.....	10







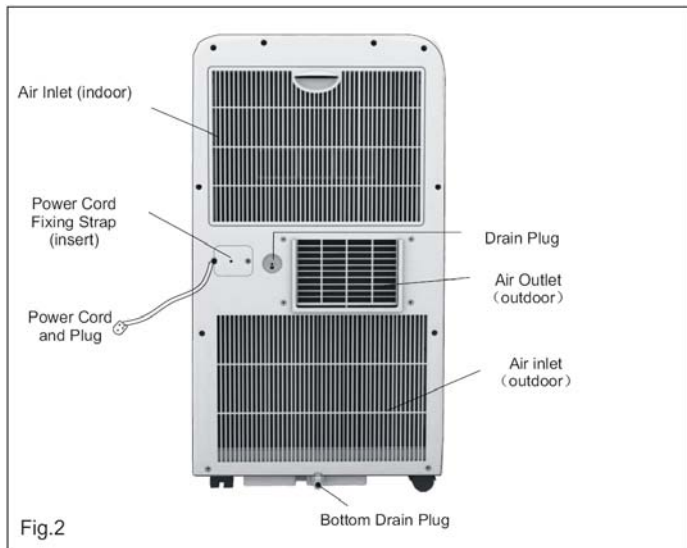

Safety Rules

1. Do not connect unit to any AC socket in disrepair.
2. Do not use in the following locations:
 - A: Next to source of fire
 - B: An area where oil is likely to splash.
 - C: An area exposed to direct sunlight.
 - D: An area where water is likely to splash.
 - E: Near a bath, a shower or a swimming pool.
3. Never insert your fingers or any foreign objects into the air outlet. Take special care to warn children of these dangers.
4. Always store the unit upright in order to maintain the compressor in a proper condition.
5. Be sure to unplug the unit before cleaning.
6. The heater must not be located immediately below a socket outlet.
7. If the appliance is covered, there is a risk of overheating.
8. If the plug or electrical cord is damaged, it must be replaced by the manufacturer or its service agent or a similarly qualified person in order to avoid a hazard.

Names of Parts

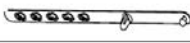

Accessories

PARTS :	PARTS NAME :	QUANTITY :
	Duct	1
	Adaptor A (for permanent duct mounting)	1
	Adaptor B (for temporary duct mounting)	1
	Expansion plug	4
	Power Cord Fixing Strap (for bundling the power cord)	1
	Drain Hose(Continuous drainage)	1
	Drain Hose(Connected with water tank)	1
	Window Slider Kit	1

Check all the accessories are included in the package and please refer to the installation instructions for their usage.

Operation Panel

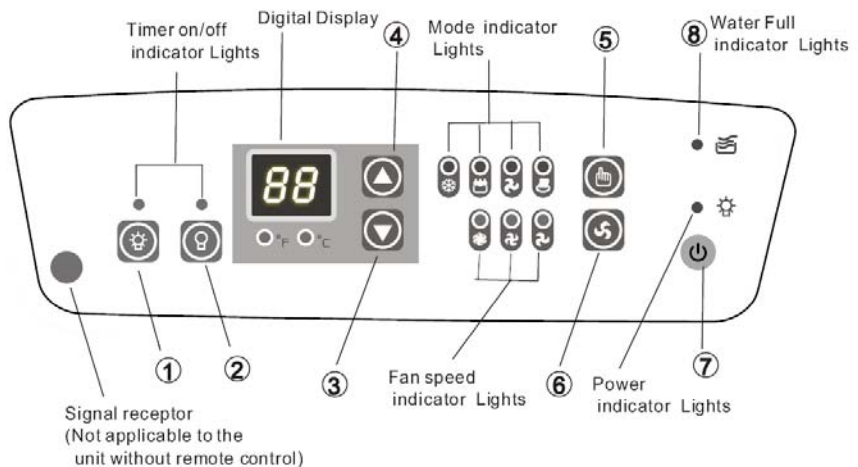

Fig.3

Key Pad Functions Fig.3

- ① **TIMER ON Button:** Used to initiate the AUTO ON start time program, and used to adjust Auto-Timer settings.
- ② **TIMER OFF Button:** Used to initiate the AUTO OFF stop time program, and used to adjust Auto-Timer settings.
- ③ **▲** Used to adjust (forward) temperature settings(1°C/2°F increments).
- ④ **▼** Used to adjust (backward) temperature settings(1°C/2°F increments).

- ⑤ **MODE Button:** Selects the appropriate operating mode:
Cool-Heat-Fan-Dry (Dehumidify).

Note:"Heat Mode" is for Heating/Cooling Model only.

MODE Indicator Lights(Green light): Illuminates under the different mode settings:

COOL Mode ()--HEAT Mode()--FAN Mode()--DRY(Dehumidify) Mode ()

- ⑥ **FAN Button:** Selects High-Medium-Low fan speeds

FAN Indicator Lights(Green light): Illuminates under the different mode settings:

High Fan Speed ()--Medium Fan Speed ()--Low Fan Speed ()

Fan Options:

Cooling (3 speeds) **High-Medium-LOW.**

Heating (2 speeds) **High-Low.**

Dry-Dehumidifying (1 speed) **High.**

Fan (3 speeds) **High-Medium-Low.**

- ⑦ **POWER Button:** Power switch On/Off.

- ⑧ **Water Full Indicator Light:** Flashes red when the water level of the water tank exceeds the maximum set level or if the water tank is not correctly positioned in the cabinet.

- ⑨ **Digital Display Window:** Shows the setting temperature and Auto-On/Off time. While on DRY and FAN mode, it shows the room temperature.

● **Note:** This appliance provides a feature that will allow you the option of setting temperatures in "Celsius" or "Fahrenheit" . To change the temperature display on the main unit, press the "▲" key pad & "▼" key pad "simultaneously" to alternate between the °C & °F scale.

Celsius scale allows adjustments of 1°C increments.

Fahrenheit scale allows adjustment of 2°F increments.

Temperature Conversion Chart	
°C	10 11 12 13 14 15 16 17 18 19 20 21 22 23 24 25 26 27 28 29 30 31 32 33
°F	48 50 52 54 56 58 60 62 64 66 68 70 72 74 76 78 80 82 84 86 88 90 92 94

Operating Instructions

Before Starting This Unit

- 1) Select a suitable location, make sure you have easy access to an electrical outlet.
- 2) Install the Flexible Exhaust Hose and the Adjustable Window Slider Kit as depicted in Fig.4 & Fig.4a

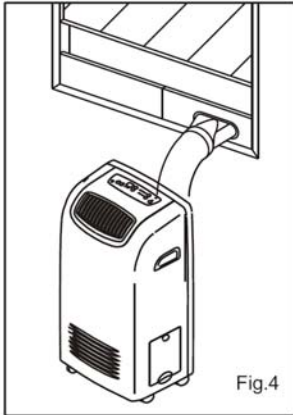

Fig.4

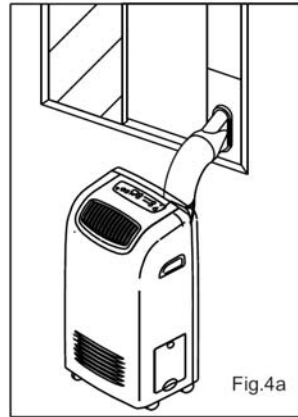

Fig.4a

NOTE: Step 2 is required only while using the cooling mode .

- 3) Plug the unit into a 220-240V~50Hz/ or 115V~ 60Hz (Refer to the nameplate located on the right side of the unit.) grounded electrical outlet. DO NOT USE A REGULAR EXTENSION CORD. If it is necessary to use an extension cord with this unit, use an approved air conditioner extension cord only.
- 4) Insert the power cord fixing strap into the hole in the back of the unit, and bundle up the excess cord.
- 5) Make sure the Water tank is correctly positioned inside the cabinet otherwise the unit will not operate.
- 6) Press the on/off button to turn on the unit.

Electrical Requirement

1. All wiring must comply with local and national electrical codes and be installed by a qualified electrician. If you have any questions regarding the following instructions, contact a qualified electrician.
2. Check available power supply and resolve any wiring problems BEFORE installation and operation of this unit.
3. For your safety and protection, this unit is grounded through the power cord plug when plugged into a matching wall outlet. If you are not sure whether the wall outlets in your home are properly grounded, please consult a qualified electrician.
4. The manufacturers nameplate is located on the right side panel of the unit and contains electrical and other technical data specific to this unit.
5. To avoid the possibility of personal injury, always disconnect the power supply to the unit before installing and/or servicing.

Operating Instructions

1 COOLING OPERATION (Operating temperature range: 17°C-32°C)

- Press the "MODE" button several times until the "COOL" indicator light comes on.
- Press the "TEMP SETTING" buttons "▲" or "▼" to select your desired room temperature. The temperature can be set within a range of 17°C-30°C.
- Press the "FAN SPEED" button to choose the fan speed.

2 DEHUMIDIFYING OPERATION (Operating temperature range: 13°C-32°C)

- Press the "MODE" button several times until the "DRY" indicator light comes on.
- Under this mode, you cannot select a fan speed or adjust the temperature. The fan motor operates at High speed.
- Keep windows and doors closed for the best dehumidifying effect.
- Do not put the duct to window.

CAUTION: During Cooling and dehumidifying modes, if the compressor cycle is interrupted (unplugged, power failure, etc.) and reinstated immediately thereafter, a compressor protection circuit is automatically self-affected. The compressor cannot operate during a compressor protection condition. It may take about 3 minutes before the protection circuit self-deactivates. (This is normal)

3 HEATING OPERATION (Cooling only type without heat feature)

(Operating temperature range: 5°C-30°C)

- Press the "MODE" button several times until the "HEAT" indicator light comes on.
- Press the "TEMP SETTING" buttons "▲" or "▼" to select your desired room temperature. The temperature can be set within a range of 17°C-30°C/62°F-88°F.
- Press the "FAN SPEED" button to choose the fan speed.
- Do not put the duct to window.

4 FAN OPERATION

- Press the "MODE" button several times until the "FAN" indicator light comes on.
- Press the "FAN SPEED" button to choose the fan speed. The temperature cannot be adjusted.
- Do not put the duct to window.

5 TIMER OPERATION

Setting the on timer:

- Press the "TIMER ON" button when the air conditioner is off.
- Continue pressing or keep pressing the "TIMER ON" button to select the time you need the unit start to operate. The time is programmed as :0.5-1.0-1.5-2.0-2.5-3.0-3.5-4.0-4.5-5.0-5.5-6.0-6.5-7.0-7.5-8.0-8.5-9.0-9.5-10-11-12-13-14-15-16-17-18-19-20-21-22-23-24-0.0
- The starting time is adjustable from 0.0 to 24.

Setting the off timer:

- Press the "TIMER OFF" button when the air conditioner is on. Continue pressing or keep pressing the button to select the time you need the unit turn off. The Operation Panel Window will display "OFF TIME".
- The turning off time is adjustable from 0.00 to 24.

Installation

1. Window Kit Installation

Your window kit has been designed to fit most standard Vertical and horizontal window applications. However, it may be necessary for you to improvise/modify some aspects of the installation procedures for certain types of window. Please refer to Fig. 7 & Fig. 7a for minimum and maximum window openings.

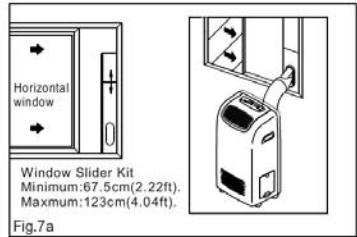
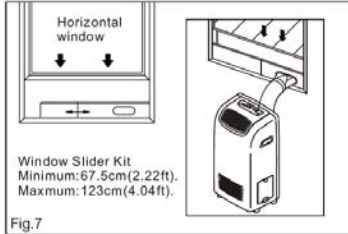

Note: If the window opening is less than the above mentioned minimum length of the window slider kit, cut that one with a hole in it short to fit for the window opening. Do never cut out the hole in window slider kit.

2. IMPORTANT:

Install the mobile air conditioner in a flat and spacious location where the air outlets will not be covered up. A minimum clearance of 30cm from a wall or other obstacles should be kept. The appliance shall not be used in the laundry. The plug shall be accessible after appliance is positioned. Wiring shall be done according to National rules.

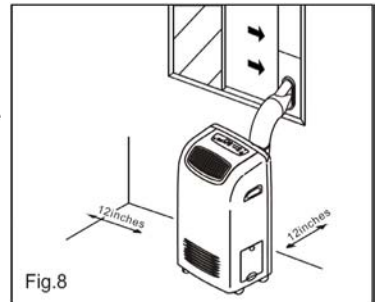

3. Duct Mount Installation

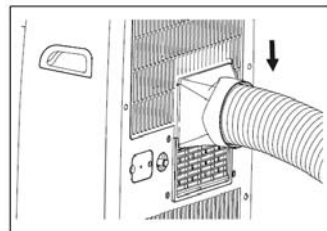
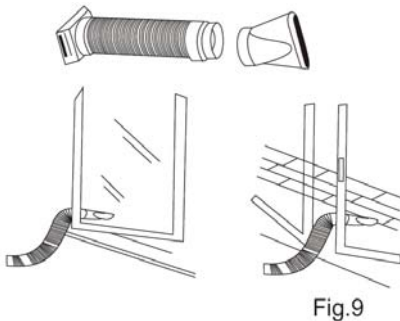

A) TEMPORARY

1. Attach one end of the duct to the exhaust air outlet of the mobile air condition, push it downwards, be sure to fix thoroughly. (See Fig.9)
2. Attach the other end of the duct to adaptor B.
3. Put the end of duct to a nearby window.

B) PERMANENT

1. Attach one end of the duct to the exhaust air outlet of the mobile air conditioner. According to the arrow direction, push it downwards, be sure to fix thoroughly. (See Fig.9)
2. Install the adaptor A onto the wall by using 4 expansion plugs and screws, be sure to fix thoroughly. (See Fig.10)
3. Attach the other end of the duct to adaptor A.
4. Cover the hole using the adaptor cap when not in use.

The duct can be compressed or extended between 20" and 78" but it is desirable to keep the duct length to a minimum.

IMPORTANT:

DO NOT OVER BEND THE DUCT (SEE Fig.11)

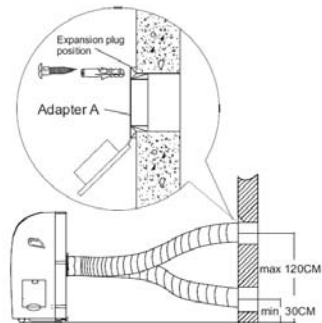

Fig.10

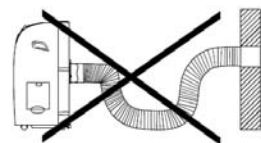

Fig.11

4. WATER TANK SAFETY FEATURE

This unit is equipped with a water tank which is fastened with a band to protect the water level switch in transportation. Prior to the first usage, remove the water tank from the air conditioner and remove this band (see figure 13). Return the water tank to its original position in the air conditioner.

When the water level reaches a pre-determined level within the tank, the digital display will show "P1" and the water full indicator light will flash (red). Carefully remove the water tank from the cabinet and dispose of the water (see figure 14). Replace the water tank back to its original position. The red light will stop flashing and the "P1" will stop being displayed.

Note: When you remove the water tank, please do so slowly and gently to prevent from spilling the condensed water.



Fig.12

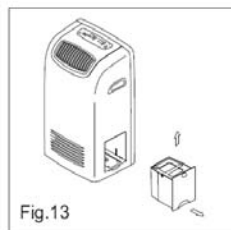

Fig.13

Maintenance

IMPORTANT:

- 1) BE SURE TO UNPLUG THE UNIT BEFORE CLEANING OR SERVICING.
- 2) DO NOT USE GASOLINE, THINNER OR OTHER CHEMICALS TO CLEAN THE UNIT.
- 3) DO NOT WASH THE UNIT DIRECTLY UNDER A TAP OR USING A HOSE. THE ELECTRICAL CAUSE DANGER.
- 4) IF THE POWER CORD IS DAMAGED, IT SHOULD BE REPAIRED BY MANUFACTURE OR ITS AGENCY.

1 AIR FILTER

- Clean the air filter at least once every two weeks to prevent inferior fan operation because of dust.
- Removal
Pull out the filter cover and remove the air filter from the filter cover.
- Cleaning
Wash the air filter by immersing it gently in warm water (about 40°C) with a neutral detergent. Rinse the filter and dry it in a shady place.
- Mounting
Attach the air filter to the filter cover using the attachment hooks on the inner surface of the cover. Put the filter cover back to the unit.



Fig.14

2 UNIT ENCLOSURE

- Use a lint-free cloth soaked with neutral detergent to clean the unit enclosure. Finished by a dry clean cloth.

3 UNIT IDLE FOR A LONG TIME

- When you plan to leave this unit unused for a long time, remove the bottom rubber plug from the back hole and attach a section of the continuous drain hose. All the water in the bottom tray would drain outside through the drain hose.(See Fig.16)

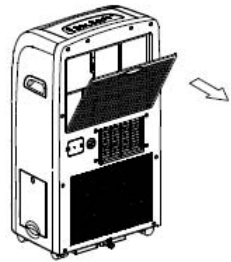

Fig.15

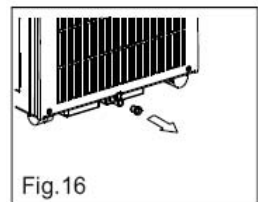

Fig.16

Troubleshooting

Troubles	Possible Causes	Suggest Remedies
Unit does not start when pressing power button	Water full indicator blinks, water tank is full	Dump the water in the water tank
	Room temperature is higher than the set temperature (heating mode)	Reset the temperature
	Room temperature is lower than the set temperature (cooling mode)	Reset the temperature
Not cool enough	The windows or doors in the room are not closed	Make sure all the windows and doors are closed
	There are heat sources inside the room	Remove the heat sources if possible
	Exhaust air duct is not connected or blocked	Connect the duct and make sure it can function properly
	Temperature setting is too high	Decrease the set temperature
	Air filter is blocked by dust	Clean the air filter
Power shut off at heating mode	The automatic overheat protection function. When the temperature at the air outlet exceed 70°C the device will stop	Switch on again after the unit has cooled down
Noisy or vibration	The ground is not level or not flat enough	Place the unit on a flat, level ground if possible
Gurgling sound	The sound comes from the flowing of the refrigerant inside the air conditioner	It is normal
Compressor does not work and the digital display area shows "P2"	The bottom tray is full	Remove the bottom drain plug and drain the water outside



ALL SEASONS
HIRE

0800 082 8001
COOLING & HEATING HIRE SPECIALIST

All Seasons Hire Ltd.
Unit 4, Harewood Farm
London Road, Andover Down
Andover, Hampshire
SP11 6LJ

Tel: +44 (0) 1264 387370 Fax: +44 (0) 1264 358478
info@allseasonshire.com